

# Internet-based Workflow-Management for Civil Engineering Projects

Uwe Rueppel, Thomas Klauer

Institute of Numerical Methods and Computer Science in Civil Engineering,

Technische Universität Darmstadt, Germany

E-Mail: {rueppel,klauer}@iib.tu-darmstadt.de

## Summary

The growing competition pressure in the building industry increases the demands on the design and construction processes in respect to economical, technical and time aspects. These demands require efficient improvements of the value-added chain, which can be realized mainly with the usage of innovative information- and communication-technologies. To support the collaboration of all participants involved in a certain building project the Workflow-Management-System "BauKom-Online" has been developed. In the focus of the system is to support the coordination of the participants and their information exchange. Such a software-method is well suited to ensure a high quality planning process. The modelling of business-processes enables a better self-comprehension of the participants work and helps to enhance the project performance.

The system architecture of BauKom-Online contains two basic components: the process-modelling tool and the workflow-engine.

The process-model contains of activities and states of the planning and construction processes and their relations. These connected processes compose the workflow. Such a process-model for engineering purposes has to satisfy several needs, e.g., the consideration of planning and building alternatives, dynamic changes of the model during execution of the project and the linkage to further technical objects like costs, building structure, specifications and document-management. Furthermore, the scheduling of the project can be done within the process-model and can be visualized as a Gantt-diagram.

By the workflow-engine the modelled processes are enacted and their execution is supervised during the realization of the actual project. The participants interact with a task-list, which is derived from the running process-model instance and works like familiar email-clients. The currently executed workflow and its status can also be visualized in a web-browser. Another important feature of the workflow-engine is the case-based exception handling.

## 1 Introduction

The building industry is characterized by a very strong division of labor which puts high claims onto the coordination of the processes and also onto the quality of the information to be exchanged. In spite of the current possibilities that are available through information and communication technologies, there does not exist any comprehensive solution in order to fully meet the requirements of the building industry yet. Models for the coordination of the processes and workflows have not yet been developed that fit the practical use in the information and communication compound.

To enhance the cooperation of the project participants optimal process solutions are required both during the target definition and planning decisions phase and the phases of realization and controlling the project.

A project-decisive role comes up to the project management. It takes over the responsibility for function and quality, for deadlines and costs. In addition, the project management fulfills tasks in the tension field of the project participants and is endowed with decision and instruction

authorization to enforce the best possible target definition and target fulfillment. In order to perform these tasks successfully the project management needs a software-based support in coordination and controlling purposes.

Communication in building projects is afflicted with media discontinuity and loss of information. In order to prevent these problems, a continuous structure must be guaranteed in the entirety of the execution of a building project. With the information and communication technologies several methods are available to provide support for these tasks. Project communication systems (PCS), implemented as place- and time-independent online portals, are state-of-the-art and used already in the building industry. Such a PCS is based on a Document-Management-System (DMS), that can handle all relevant documents like CAD-plans, contracts, bills of quantities, supplements, etc.. The structure of a DMS can be based on static file hierarchies which are adapted onto building projects. With so called *distribution lists* project participants can be notified in case of updating the information desk. Since the coordination is only weakly distinct in such systems at this time, the circle of the addressed project participants and the amount of stored information are bigger than necessary in most cases. The consequence is an information and communication flow that challenges the advantages of the used system. To work against these problems a communication platform has to be enhanced to a cooperation platform by integration of a Workflow-Management-System.

## **2 A Workflow-System for Civil Engineering Projects**

The here presented Workflow-Management-System is part of the research project "Trade-comprehensive planning and coordination of building design processes in computer networks for cost reduction on the basis of a Workflow-Management-Framework BauKom-Online (<http://www.baukom-online.de>)" supported by the German Federal Ministry for Education and Research (BMBF). The participants in this project are the Institute of Numerical Methods and Computer Science in Civil Engineering at the Darmstadt University of Technology, a Civil Engineering software company, a construction supervision authority, and companies from engineering practice. These partners are involved in the entire course of planning and construction processes. The aim of the research project is to develop an Internet portal for the integrated modelling of the entire trade-comprehensive processes of planning, projecting and construction phases.

### **2.1 Workflows and Workflow-Management-Systems**

Workflow is concerned with the automation of procedures where documents, information or tasks are passed between participants according to a defined set of rules to achieve, or contribute to, an overall business goal (WfMC, 2003).

Workflow-Management-Systems (WfMS) are software-tools, which control, supervise and coordinate workflows between several parts of organizations based on defined process models. The basic functions of a Workflow-Management-System are the modelling of the organization, the definition of activities and activity-types, the execution of the activities (Workflow-Engine) and the activity-management.

The adoption of a Workflow-Management-System in an organization means an investment, that can be justified by several fundamental advantages:

- **Increased productivity:** The saving of time becomes possible by shortening of transportation-times and the avoidance of waiting-times and through concurrent operation

- Traceability: The documentation of processes is taken over by the system. That is important in building projects since a legal certainty is necessary
- Self-conception: The modelling of organizational and procedural structures improves the self-conception of the own work
- Quality assurance: The system controls the execution of activities, provide their processing and reminds on deadlines that have to be met or have been exceeded already
- Information availability: The current processing state of a running task or process can be investigated in the sense of controlling at any time

A Workflow-Framework is a system, that enables a procedural automatization of business processes through coordination of workflows and integrating of correspondent human or IT-resources that are related to certain activities.

Standardizations in the area of Workflow-Management are promoted primarily by the Workflow Management Coalition (WfMC, (WfMC, 2003)) and the Business Process Management Initiative (BPMI, (BPMI, 2003)).

Workflow-Systems are specific kinds of CSCW-Systems (Computer Supported Cooperative Work), which support a group of actors (team) in the execution of tasks (business processes). Workflows can be categorized as follows:

Ad-hoc Activities	Independent Teamwork	Semi-Structured Processes			Structured Processes
		Open Group Processes	Controlled Group Processes	Ad-hoc-Modification of Structured Process	
					

Figure 1 : Workflow-Classification (Nastansky et al., 1994)

#### Unstructured processes

Ad-hoc activities are used for urgent, short-lived worksteps or in exception situations. A responsibility assignment based on a mail-system is an application for this purpose. During the independent teamwork a concurrent access occurs on information concerning a common task. Both process structures are used in building projects.

#### Structured processes

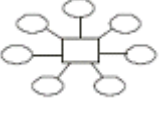
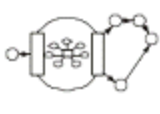
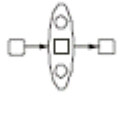
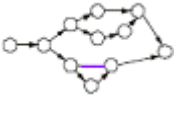
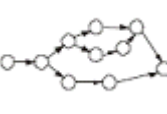
Structured processes can be used for reiterative processes with foreseeable situations. Such systems are used for example in credit processing applications, but they are unsuitable for building projects with many dynamic changes during the projects (v.d.Aalst et al., 2002).

#### Semistructured processes

Semistructured processes represent a hybrid type. Open group processes do not contain any process rules but require initial and output information for the activities. Controlled group processes are restricted to a certain circle of participants with different access authorizations.

A Workflow-classification suitable for building projects is a predefined, structured process with the possibility of ad-hoc modifications (Klauer, 2003 / v.d.Aalst et al., 2003). It can be reacted flexible on specialties in the sense of dynamic changes during process execution (exceptions). These exceptions can be provided, if known, as a rule already before execution of the process.

## **2.2 Conceptual design of a Workflow-System for Civil Engineering Projects**

### **2.2.1 Consideration of Specialties in Civil Engineering Projects**

Production- and delivering-enterprises in several branches of industry, for instance, in the car-industry, act in fixed and well-rehearsed structures (Leymann et al., 1999 and Scheer, 2001). In the building industry joint-ventures are binding only for the duration of a specific project. Every building is a unicum, for whose production planning-specialists and executive companies join project-specifically, and, in addition, several trades must be coordinated. Nevertheless, subprocesses which show a reusability potential are found even in the building industry. Exactly these processes have to be identified so that they can be provided for succeeding, future projects as workflow-templates in a central database called *Repository*. These processes can be integrated, if required, into a certain project. Through that, the error-prone and time-extensive planning and organization of the workflows can be simplified.

The realization of building projects is afflicted with great dynamics during the project execution. This results very frequently in variances of the defined process model. These situations are referred in the workflow-language as *exceptions* which require a case-specific processing.

### **2.2.2 Workflow-Elements**

The root-element of the introduced workflow-concept is called *package*. It represents a summary of all processes of a project-workflow in the definition as well as in the execution. The actual workflow is contained inside the processes, which are composed of activities, states and the relations among themselves.

*Activities* can be executed by project participants, e.g., preparing a CAD-plan, or processed automatically by applications, like in a notification system. The activity itself represents an important element of the here presented system. It can be an own process containing further subordinate activities (subflow) or can be not demountable in further sub-activities (atomic).

*States* can be treated as snapshots of the workflow-system and describe a situation at a certain point of time. In building projects they are planning or building states for example.

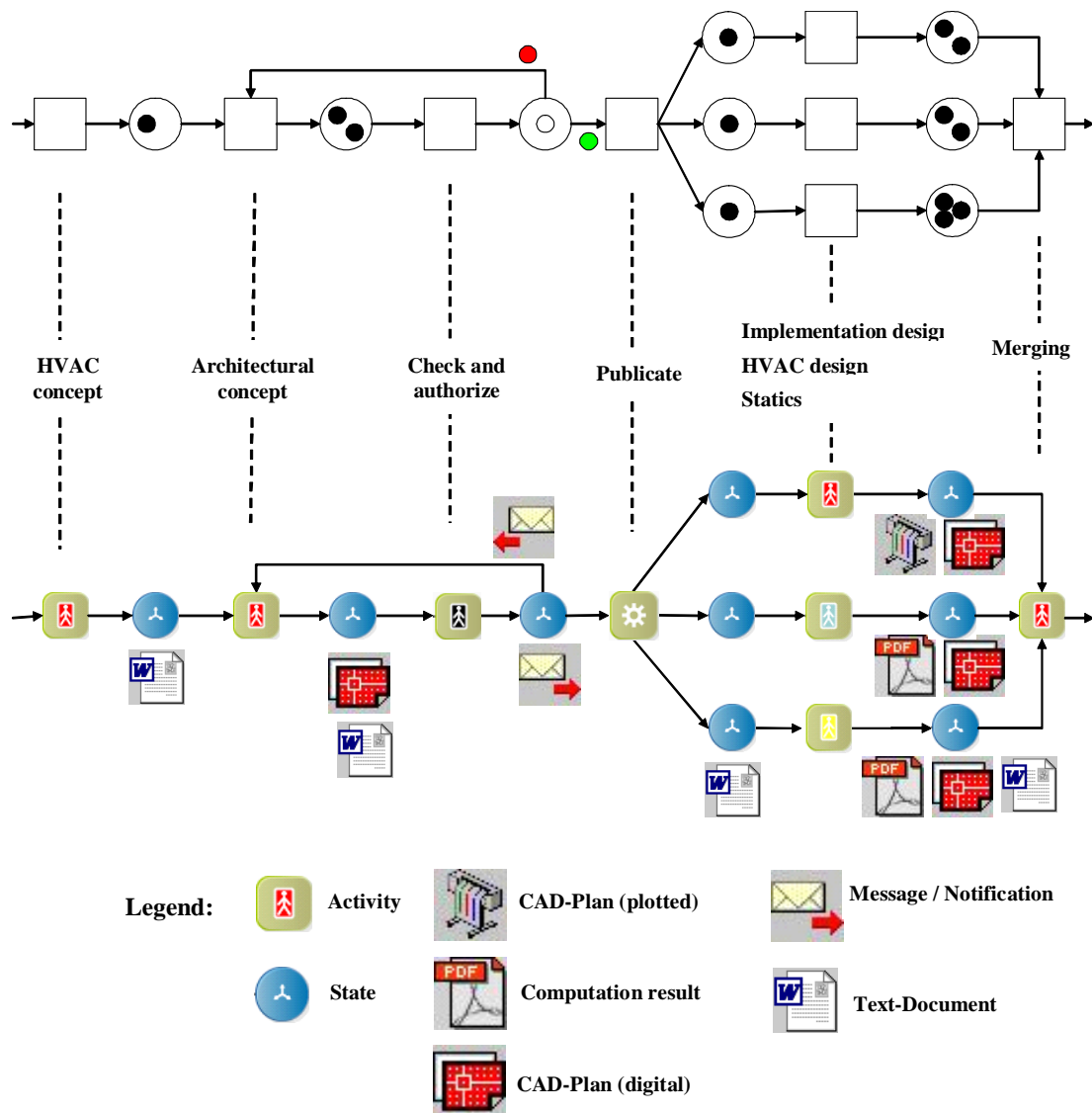

Figure 2: State representation in planning processes

Figure 2 shows a section of a process of the implementation planning. The states are represented by a set of document based information or by messages. Every document or every information can be equated with an individual token of a Petri net (Rüppel et al., 2002). States always result from activities and are results of finished activities as well as the basis for following activities. A Workflow-System must ensure that the considered system has to be in a constant state at any time and previous states can be reconstructed (rollback).

#### Process-structures

A process contains different structures of activities and states. These are iterations (loops), hierarchical structures of processes and branching points (splits and joins).

If the control flow is divided up onto several activity instances, which are carried out simultaneously, an *AND-split* is used. The point at which this control flow is combined again is called *AND-join*. A branching, of which in each case only one path (exclusive or - XOR) or not all paths are executed, is named *OR-split*. The reunion of alternatives is called *OR-join*.

This case represents a special situation, seen in Figure 3, because there are existing several possibilities concerning the succeeding way in the workflow which means, that the workflow

can not be visualized in one Gantt-diagram. The workflow illustrated in figure 3 contains two possibilities on completion of process 1. Depending on the decision, which of these possibilities occurs according to defined conditions, another workflow-path is executed. With the number of decisions in a workflow increases, the number of the possible paths increases, too.

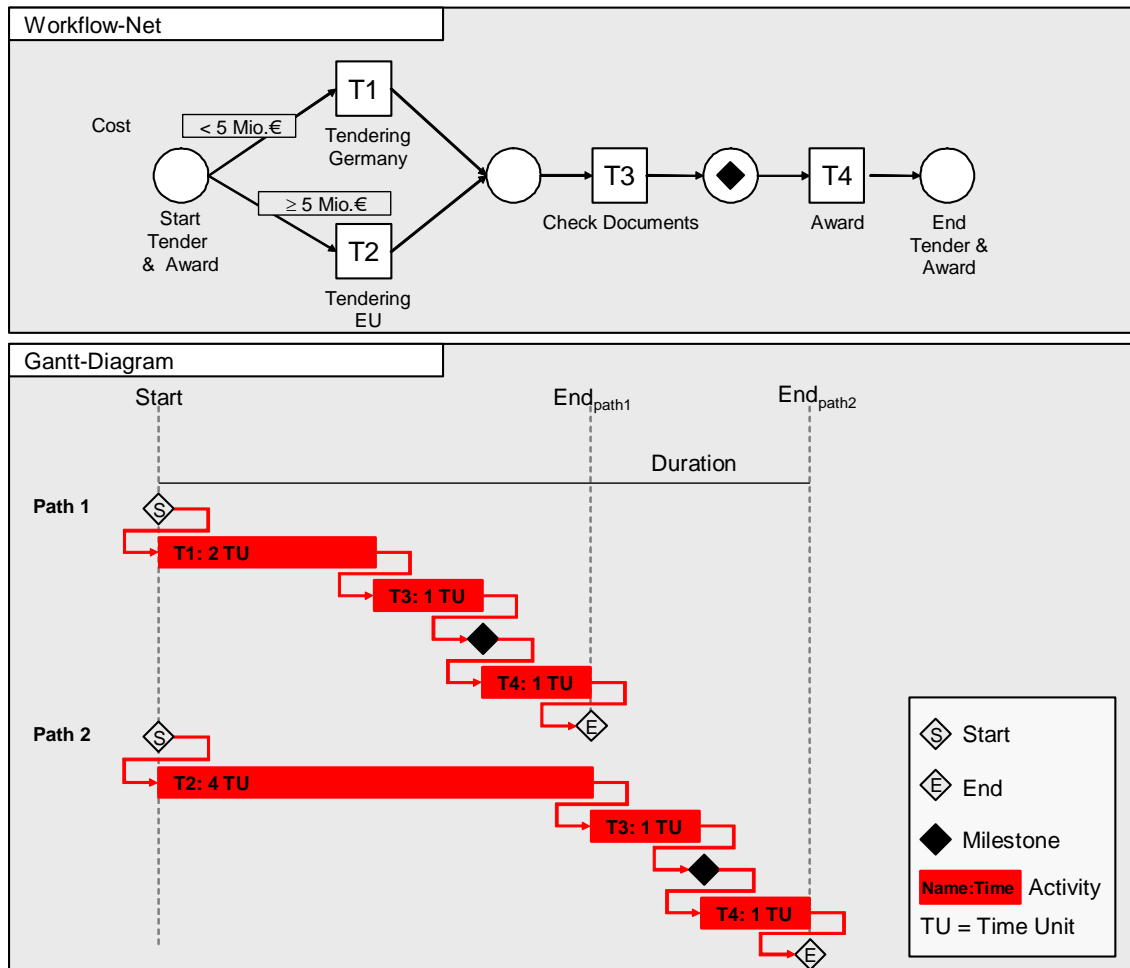

Figure 3 : (Critical) Paths with alternatives ("OR"-relations)

### 2.2.3 The Workflow-Engine

The here introduced Workflow-Engine offers functionality which is important for the efficient computing of processes during execution of civil engineering projects in order to support the project participants in their work. The different elements of a process run through a queue of statuses. These can give information about the current state of the process-elements at every time. Since these elements have already been instantiated and represent a concrete task or process at runtime, they are not called *processes* and *activities* anymore, but *work-units* or *work-items*. A work-item represents an entry in a work list (Jablonski et al., 1997) and is not to be compared with an operation step because it can represent a superordinate process.

This structuring of work units is derived from the structure of the process hierarchy from the model-definition. An atomic work unit corresponds accordingly to an operation step, that means an instance of an activity. Work-items are subdivided into different types which characterize a certain kind of execution of the work-item. This type determines the permissible status and the status transitions of the elements. The status indicates in which stage of execution the work-item is. Based on methods of the transaction management a status can be rolled back in order to ensure the consistence. Following work-items have been implemented:

The work-item *Project* represents a complete Workflow-project or package that is instantiated for a certain building project. A package contains the main process and several subprocesses. The *Process* work-item stands for an individual process, that is a part of a project at runtime.

A *Task* is an activity at runtime. It can be processed automatically (through the Workflow-System or an external application) or as a single operation step in a work list by a project participant. Figure 4 shows the status transitions of this work-item. It can be indicated, whether the task-execution can be ended directly or through a releasing mechanism. The work-item *release* is generated if defined in the process model.

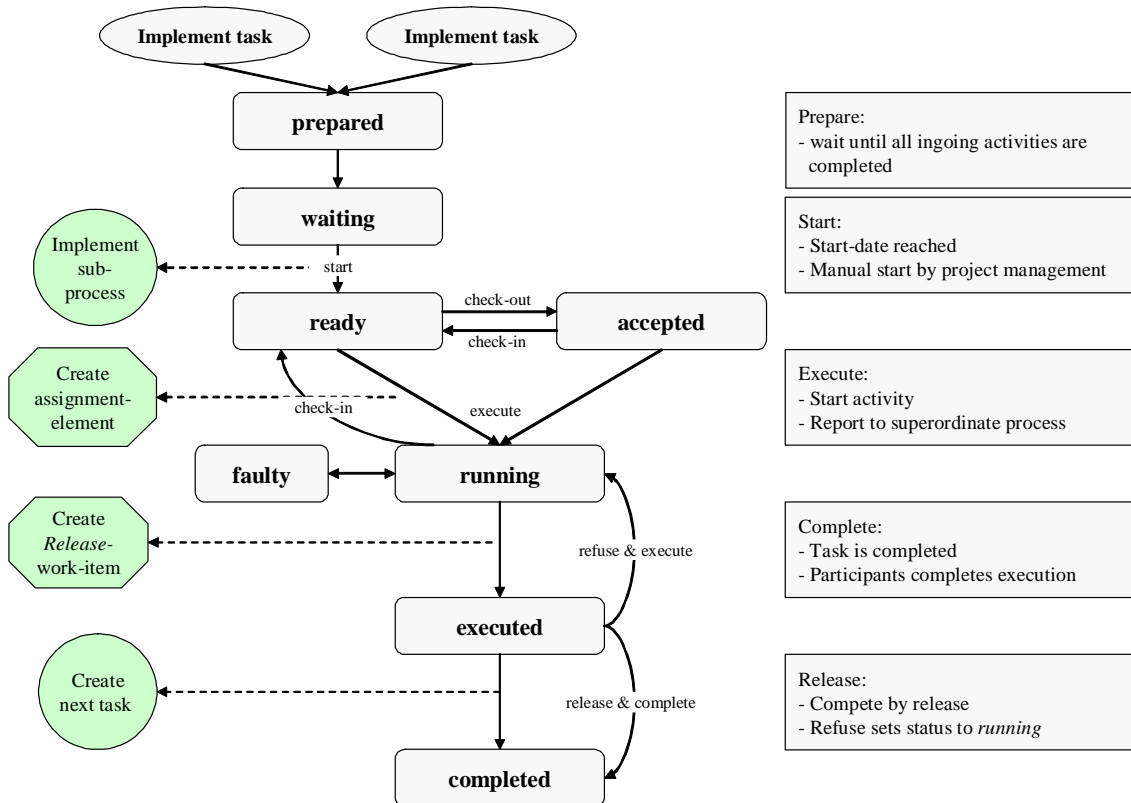

Figure 4: Status transitions of the Task work-item

*User Decision* work-items are used when the control flow reaches an OR-split whose conditions could not be resolved automatically. If a work-item of the types *Task* or *User Decision* can not be executed completely so a divergency from the planned workflow becomes necessary, a work unit of the type *Exception* is generated.

The work-item *Error* is created if an error occurs during the computing of a process.

#### 2.2.4 Dynamic Changes during Project Execution

An exception can be seen as foreseeable or unforeseeable deviation from the specifications of a process model. It refers to facts or situations that are not modelled in an information system. The flexibility of a Workflow-Management-System can be divided in two categories with regard to the finding and processing of exceptions (Joeris, 2000):

The *a priori* flexibility covers all measures that are suitable at build time to enable a flexible definition and execution of a Workflow. A priori exceptions are deviations with known context of their occurrence as well as known actions necessary for their processing. This means that exceptions of this kind can already be considered during process modeling.

A *posteriori* flexibility contains all aspects which are determined to handle the subsequent change of a process and the evolution of process models during the execution of a civil engineering project. The first fence that must be overcome is the recognition of the exception. If the exception is not perceived at all, it can not be handled either. If the deviation is recognized, it must be checked whether the exception is known. A known exception is an indeed not planned, but nevertheless known deviation. The counterpart is an unknown, up to now not occurred exception. In addition, known exceptions can be differentiated between known or unknown exception handling methods.

In the BauKom-Online Workflow-Management-System three modification strategies, shown in figure 5, have been implemented to enable a flexible exception handling: *Rebound*, *Insert* and *Jump*.

With a *Rebound* the workflow can be redirected to an earlier state of execution, e.g., in case of iterative planning processes.

*Inserts* allow to append additional activities. Their need is not recognized until runtime because of different reasons like unexpected situations or some activities have been forgotten during modelling. This modification can be called *schema-evolution*. The execution of additional activities or processes can be modelled a priori with the aid of decisions (OR-split). If the exception condition is set during execution, the exception-activity can be included to the workflow. The additional activities or processes that are not plannable a priori represent the greater problem. They require an ad-hoc modification of the workflow and are able to invalidate the whole scheduling according to the case of application. If the free buffer of the affected activities is exceeded, delays in planning or building are unavoidably. This causes also troubles with the resource planning and additional costs in most cases.

With *Jumps* the running process can be directed to any state of execution before or after the current state. This means the entry node is identified during the handling of the exception.

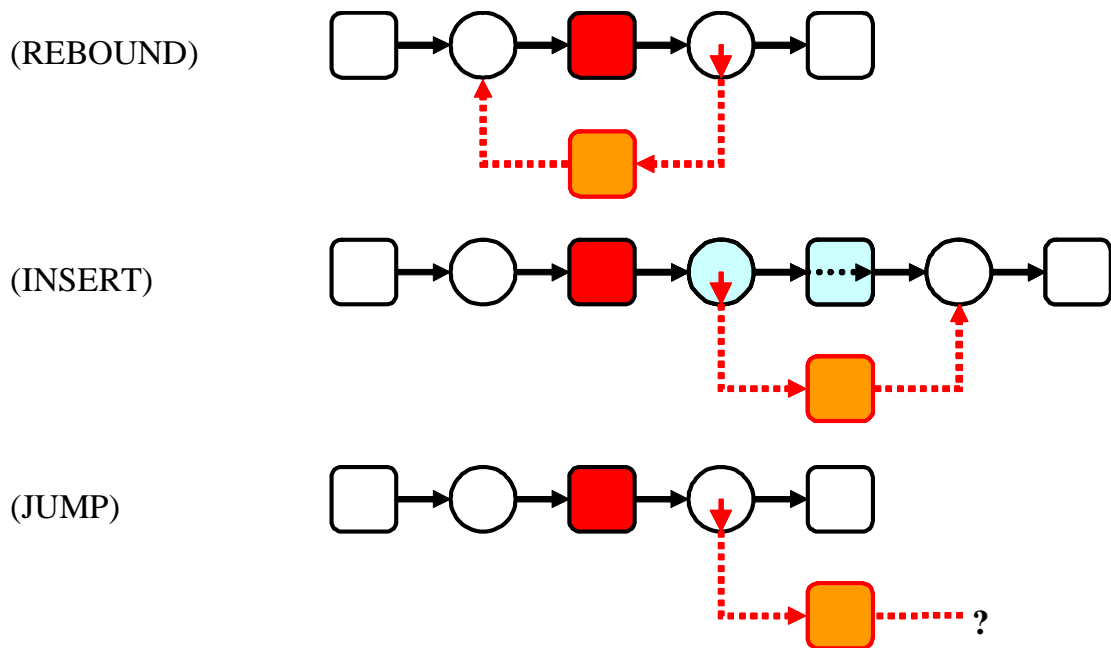

Figure 5 : Modification strategies

*Delays* without adding additional activities represent another exception problem. Activities with durations that are not forecastable exactly can be considered a priori by the usage of buffers according to the Critical Path Method. A posteriori the handling is similar to the Inserts.



### 3 Implementation of the Internet-based Workflow-System

On the basis of the Active Server Pages (ASP) - technology an Internet-based Workflow-System has been designed and implemented. This system meets the above-mentioned demands of the building industry. The Workflow-System is divided in three tiers, the persistence tier, the business tier and the presentation tier. If the application logic is changed, no re-compilation of the client applications is required.

The multi-tier architecture, illustrated in figure 6, introduces a further tier: the tier of the business objects (BO) . These objects aim to use the application more flexible in the net.

The client is supposed to act just as an user interface. The *Workflow-Editor* is a graphical user interface inside the *presentation tier* which interacts with the Workflow system. Both Workflow-Nets and Gantt-diagrams can be modelled or viewed graphically with this tool.

Because this functionality can not be implemented with common ASP web application methods the Scalable Vector Graphics (SVG) - technology, that has been created by Adobe (Adobe, 2003) and standardized by the W3C, had to be used. SVG is used to develop two-dimensional, dynamic graphic objects, that can be visualized interactively with a web-browser Plug-in.

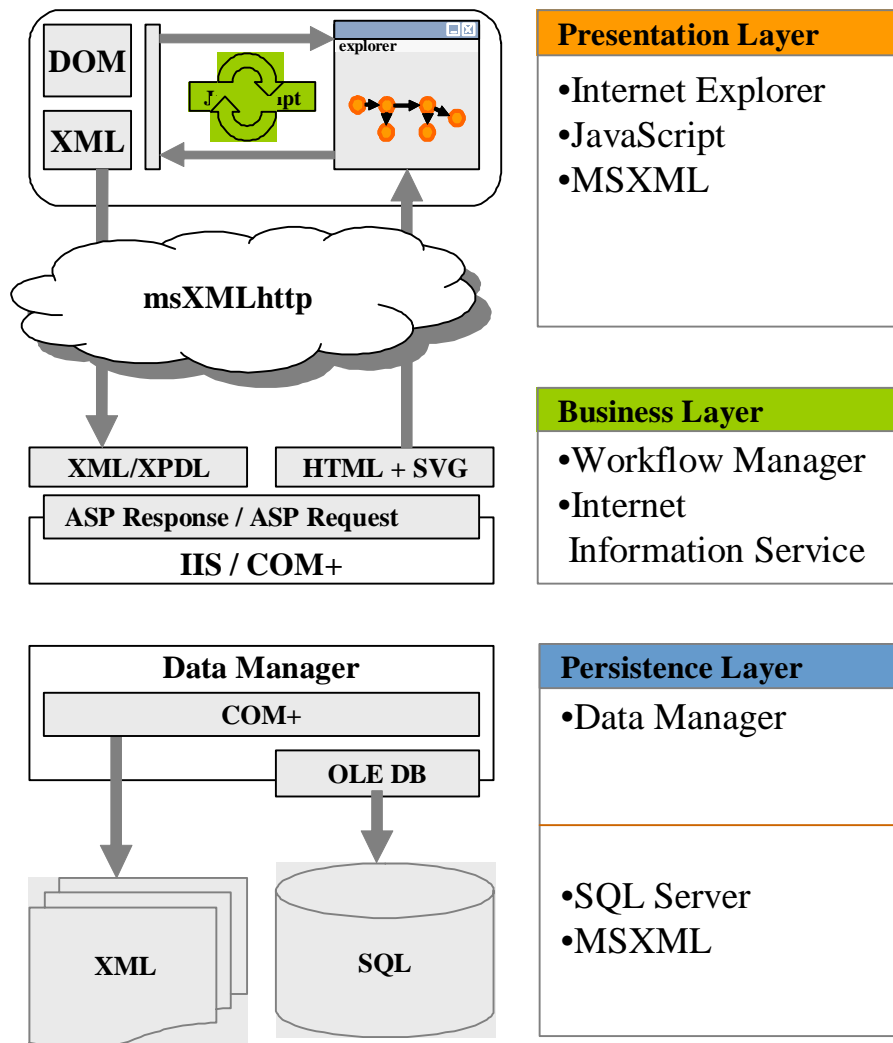

Figure 6: Three-tier application architecture of the Workflow-System in BauKom-Online

The application logic of the Workflow-system is processed in the *business tier* with the support of business objects. These have been developed as COM+-components and are connected to the

database management system (*persistence tier*) via a data abstraction layer for the purpose of persistence. The *data-manager* is used as an interface between the process definition and the runtime environment. The communication between client and server occurs via the standard Internet protocol http and the model data streams are coded in the markup language XML. The scheme of these XML-descriptions for Workflow-Management, the XML Process Definition Language (XPDL), has been defined by the Workflow Management Coalition (WfMC, 2003). By means of this scheme processes can be defined in XML and exchanged between the introduced tiers.

#### **4 Conclusion**

A Workflow-Management-System with processes-modeling capabilities is a necessary tool to ensure the given cost- and time-limitations, however also the quality of the product to be created in civil engineering projects. At that civil engineering has specific requirements on such systems since there is a high dynamics with numerous divergencies from the defined process model because of the unicum manufacturing.

The here presented, Internet-based Workflow-Application is a system that takes these specific demands into consideration and supports the cooperative work in civil engineering projects.

Current and future investigations deal with a development of the analysis-tools (Petri net methods, (Petri, 1962), (v.d.Aalst, 1998) and (Rueppel et al., 2002)) and the processing of exception situations.

#### **5 References**

(Adobe, 2003)

Adobe: Scalable Vector Graphics Spezifikation, 2003

(BPMI, 2003)

Business Process Management Initiative: Documentations and Whitepapers, [www.bpmi.org](http://www.bpmi.org), 2003

(Jablonski et al., 1997)

Jablonski, Stefan; Böhm, Markus; Schulze, Wolfgang: Workflow-Management – Entwicklung von Anwendungen und Systemen, dpunkt.verlag, 1997

(Joeris, 2000)

Joeris, G: Flexibles und adaptives Workflowmanagement für verteilte und dynamische Prozesse, Dissertation, Universität Bremen, infix-Verlag, DISDBIS 69, 2000

(Klauer, 2003)

Klauer, Thomas: Ein internetbasiertes Workflow-Management-System für Bauprojekte, in: Forum Bauinformatik, Shaker Verlag 2003

(Kochendörfer 2001)

Kochendörfer, Bernd; Liebchen, Jens: Bau-Projekt-Management Grundlagen und Vorgehenswissen, Teubner-Verlag 2001

(Leymann et al., 1999)

Leymann, Frank; Roller Dieter: Production Workflow - Concepts and Techniques, Prentice Hall, 1999

(Nastansky et al., 1994)

Nastansky, Ludwig; Hilpert, Wolfgang: The GroupFlow System: A Scalable Approach to Workflow Management between Cooperation and Automation, in: Wolfinger, Bernd (Ed.): Innovationen bei Rechen- und Kommunikationssystemen - Eine Herausforderung an die Informatik, Proceedings of 24th Annual Conference of the German Computer Society during 13th World Computer Congress, IFIP '94, Springer Verlag 1994.

(Petri, 1962)

Petri, Carl Adam: Kommunikation mit Automaten - Schriften des Instituts für Instrumentelle Mathematik der Universität Bonn, 1962

(Rüppel et al., 2002)

Rüppel, Uwe; Meißner, Udo; Greb, Steffen: Dynamische Bauprozesssteuerung im Netzverbund, VDI-Fortschrittbericht 1668, VDI Verlag 2002

(Scheer, 2001)

Scheer, August-Wilhelm: ARIS - Modellierungsmethoden, Metamodelle, Anwendungen, Springer Verlag 2001

(Stoffaneller, 2003)

Stoffaneller, Sascha: Change- und Time-Management in dynamischen Workflow-Prozessen, Seminar Wirtschaftsinformatik Uni Klagenfurt 2003

(v.d.Aalst et al., 2002)

Van der Aalst, W.M.P.; J.W.F. Wamelink; M. Stoffele: Workflow Management in Construction: Opportunities for the Future, Proceedings der CIB W78 Konferenz 2002: Distributing Knowledge in Building, pages 115-122, Aarhus, Dänemark, 2002

(v.d.Aalst et al., 2003)

Van der Aalst, W.M.P. ; Stoffele, M.; Wamelink, J.W.F: Case handling in construction, Automation in Construction, 2003

(v.d.Aalst, 1998)

Van der Aalst, W.M.P.: The Application of Petri Nets to Workflow Management. The Journal of Circuits, Systems and Computers, 8(1) S.21-66, 1998.

(WfMC, 2003)

Workflow Management Coalition: Documentations and Whitepapers, [www.wfmc.org](http://www.wfmc.org)